



**COMPANY
PROFILE** 2025-2024

HORIZON INTEGRATED SOLUTIONS FZC (HIS)

The best specialized Engineering firm providing a wide range of project management for industries.

www.his-partners.com





COMPANY PROFILE

2025-2024

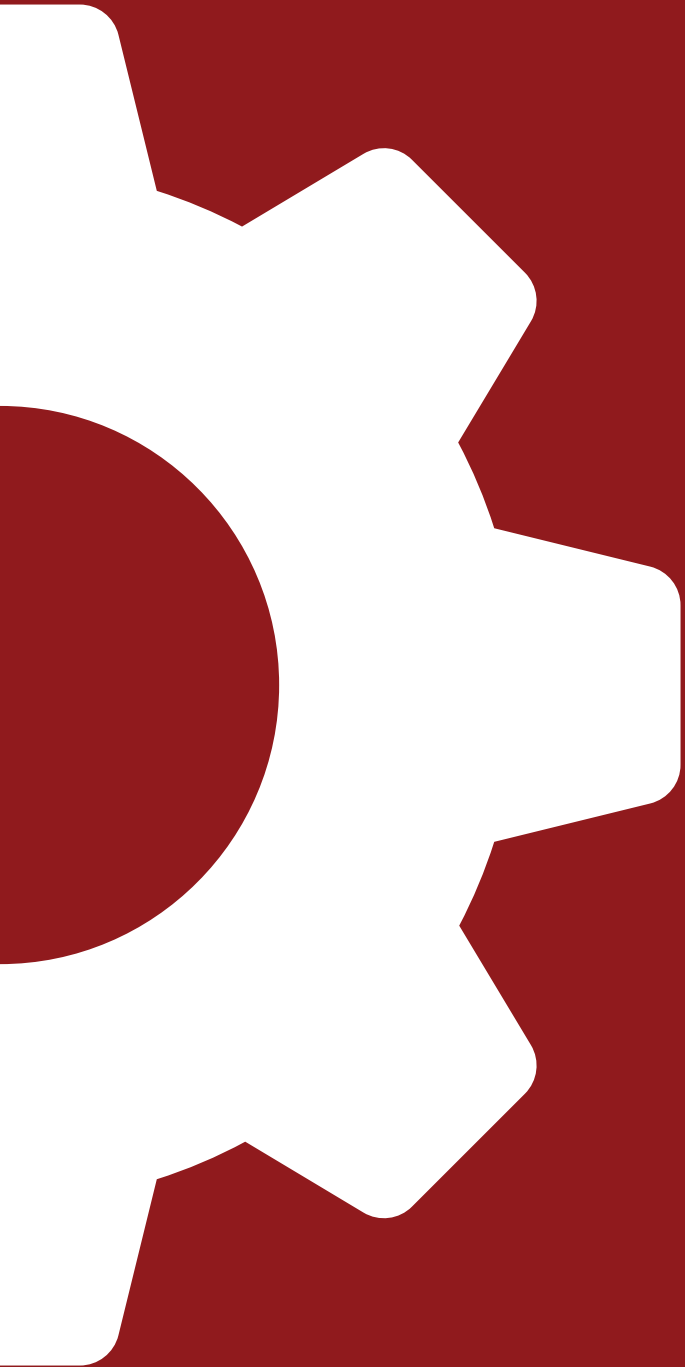

The best specialized Engineering firm providing a wide range of project management for industries.

COMPANY PROFILE

2025-2024

ABOUT US

Objectives

Horizon Integrated Solutions FZC (HIS) provides project management, planning, engineering, and related services to clients involved in F&B, Pharmaceutical and oil & Gas industries. We are an Electro-mechanical service Provider company that can serve and support your team technically with a very high level of engineering thoughts using innovation, creativity, and a wealth of knowledge.

Clients rely on HIS to deliver world-class technical solutions for assets utilization and optimization, improve competitive positions, and increase long-term business success.





CAPABILITIES

HIS's team

- We are a partners' knows how to support, select, and supply a tailor-made materials or equipment that can be under our target scope with all the necessary services.
- We have always aspired to excellence through quality, innovation and service.
- Today, we can work together with our customers to obtain the best service results in terms of quality, efficiency, and flexibility.



CAPABILITIES

Team structure





Purpose

To create and apply a high productive organizations by the most reliable and professional supportive technical team.



Mission

Combine technical requirement with work standard, services, quality and safety goals with competitive prices to provide the best result



Vision

Playing as one agile family team to get the highest productivity with a very safe environment

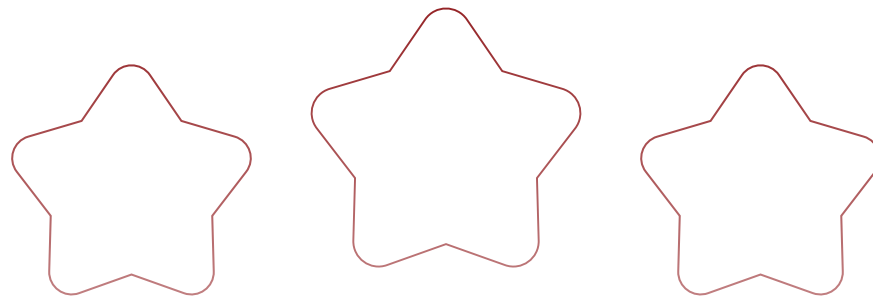

CLIENTS





SCOPE OF WORK

SCOPE OF WORK

Turn key Electro-Mechanical projects

- Mechanical and pipeline fabrication.
- Production line designs and installations.
- Utilities design and installation.
- Industrial trouble shooting solving.



In process – operation Management

- Create and manage the process after start-up and commissioning to ensure the output product can invade the local market.
- Built up all needed quality systems.
- Offer all required training technical/ soft skills to boom the learning curve of the team giving a potential startup



Supplying material

- Equipment which support and serve FMCG.
- Select the right equipment.
- Service materials and component.



Energy optimization

- Improve sites energy consumption.
- Find areas of saving.
- Solve all energy topics



TURN-KEY ELECTRO-MECHANICAL PROJECTS

We have well-known experience of how to plan and design the manufacturing plant layout with a simulation case. We review the benefits, process, and necessity for a high-quality plant layout in your business organization.

Following and committing all projects management rolls and life cycle phases (initiation, planning, execution, monitoring and closing with commissioning)

Coordinating turnkey projects from a standard technical perspective and project management to ensure a high quality of operation processes. It also entails the structural planning of departments within the factory site, the positioning of devices within the departments, and the layout of individual workstations. We are experienced to arrange the machines and equipment within a factory throw creating standard plot plans, approved layout and 3D drawings if needed for any specific areas.

Creating Piping and instrumentation diagram (P&ID) which shows the interconnection of process equipment and the instrumentation used to control the process.

Product and utilities pipeline design and fabrication based on Global welding standards.

Safety process is a must for all we do through certified EHS Management team.



TURN-KEY ELECTRO-MECHANICAL PROJECTS

Design drawings with P&ID of the plants
Real Example from our Projects

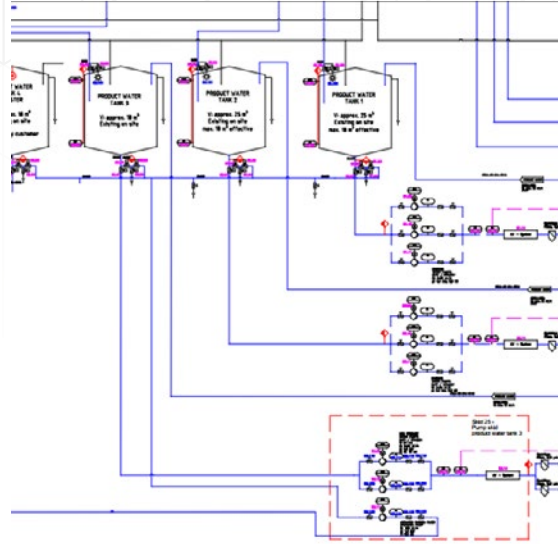
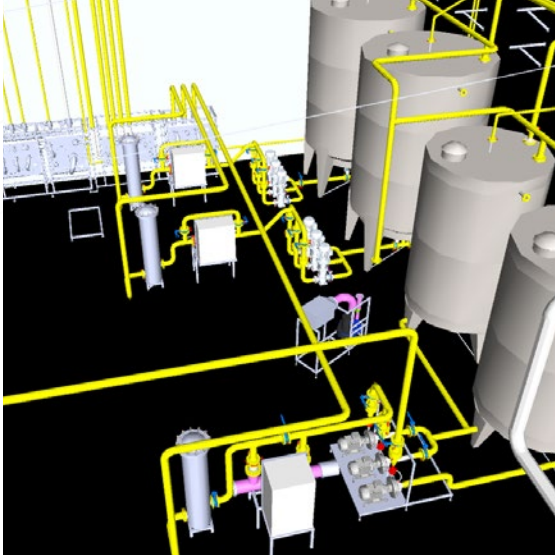

IN PROCESS – OPERATION MANAGEMENT

The most challenging part of the project is how the client will handle the project in the first few months after commissioning. New team, low learning curve, a lot to do to be capable with output products to invade target markets. We can offer our clients a full service where we guarantee the following:

1. Validating each step of the project to cover audit requirements and satisfy customer fears
 2. Build up all targeted quality systems to qualify the production lines for delivering qualified products
 3. Offer all required training technical/soft skills to boom the learning curve of the team giving a potential startup and succussed Project acceptance
 4. Support to getting targets certifications based on each market requirement Step by step to get the project milestones from draft drawings to a successful running business with measurable KPIs
- which supports management to measure the efficiency of running the business.**

Major Steps of Process Improvement using Process Mapping



SUPPLYING MATERIALS.

We are playing as a good well significant materials supplier who can support in selecting the right equipment or material which can cover your purpose. Quality, Engineering knowledge are our way of work.



ENERGY OPTIMIZATION

Optimize your energy usage, meet sustainability targets, and reduce operational costs through in-depth monitoring of energy data. Gain insights into how much energy the operation consumes on an hourly, daily, monthly or yearly bases.

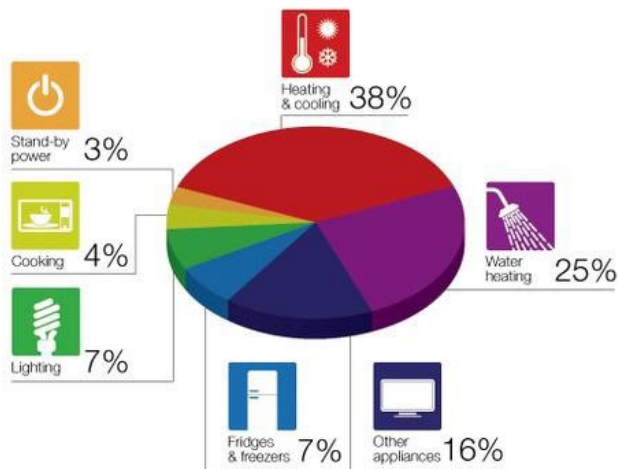
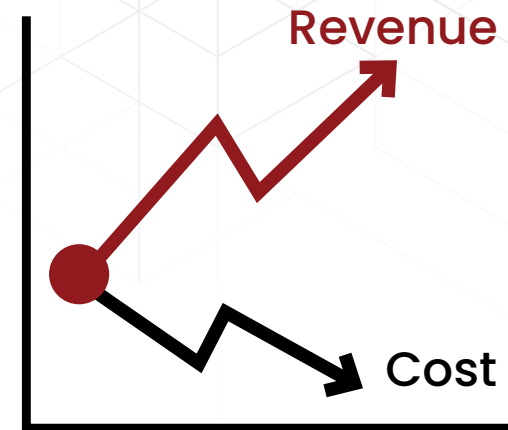



SUCCESS STORIES

SUCCESS STORIES FROM OUR PROJECTS

Pipeline design and installations for new high speed CAN line from Krones



Pipeline design and installations for new Automatic CIP unit from Krones

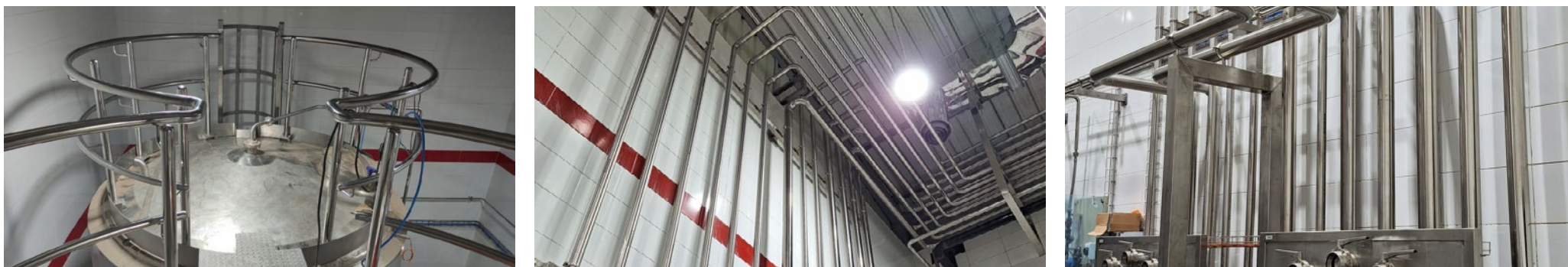

SUCCESS STORIES FROM OUR PROJECTS

Pipeline design and installations for Automatic CIP unit from ADUE Italy



PET line installations – KRONES line



GENERAL UTILITIES PROJECT

- High Pressure and Low-Pressure Compressors installation with global manufacturers (AF, Atlas Copco, Gardner Denver)
- Steam generators and industrial Boilers with global manufacture (MINGAZZINI)
- Industrial cooling systems (Ammonia and Refrigerant Chillers)
- Water treatment Plant installations and services
- Waste Water treatment plant installations and services
- Main Power stations and distribution Panels
- Industrial facilities management (Fire fighting, Plumping and HVAC)



SUCCESS STORIES FROM OUR PROJECTS

Utility room equipment re-allocation with pipeline fabrication and commissioning

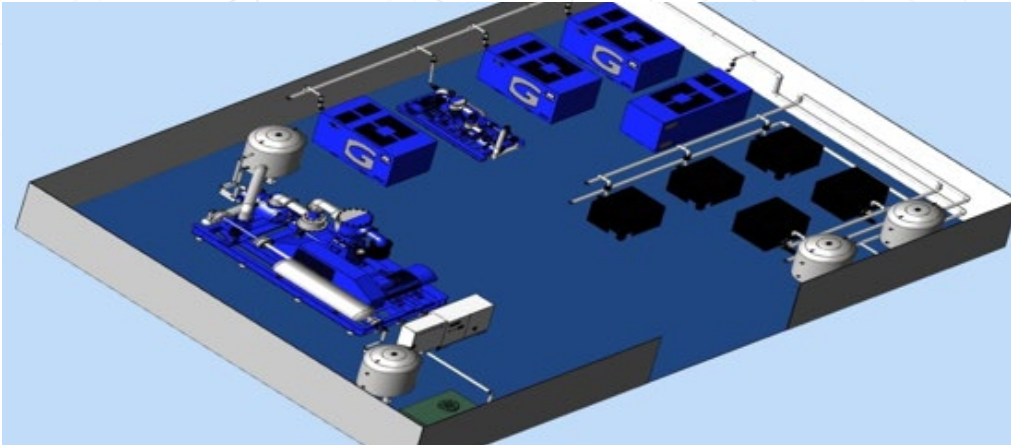

Re-allocating Ammonia chillers with installations and commissioning



SUCCESS STORIES FROM OUR PROJECTS

Supply Syrup tanks with connections to the syrup network



Installing a compressed air system with an exhaust duct



SUCCESS STORIES FROM OUR PROJECTS

Re-allocating and installing production lines and utilities



Relocating Ammonia chiller with installation and commissioning



SUCCESS STORIES FROM OUR PROJECTS

Relocating Ammonia chiller with installation and commissioning



Supplying and fabricating new syrup dissolving unit



SUCCESS STORIES FROM OUR PROJECTS

Relocating and installing high pressure compressor AF with commissioning



Installing a compressed air system with an exhaust duct



SUCCESS STORIES FROM OUR PROJECTS

Design and installations for CIP network in the whole plant



SUCCESS STORIES FROM OUR PROJECTS

Treated water distribution Manifold S.S 316 L



SUCCESS STORIES FROM OUR PROJECTS

Water treatment unit (Complete plant from CENTEC.de)

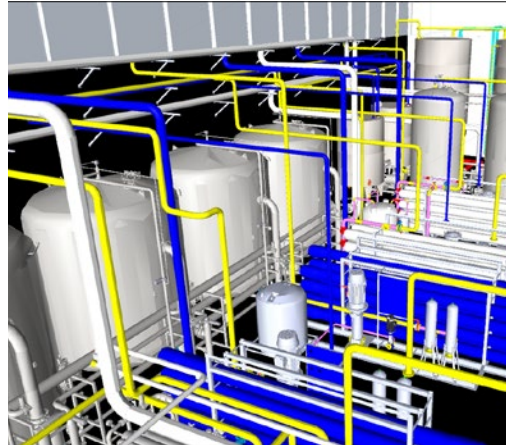



HORIZON INTEGRATED SOLUTIONS FZC (HIS)



Tel: +971503147418

Email: info@his-partners.com

Website: www.his-partners.com

Address: Office 313, P3 floor, Tower 1, The
Onyx Towers, The Greens, Dubai, UAE.